

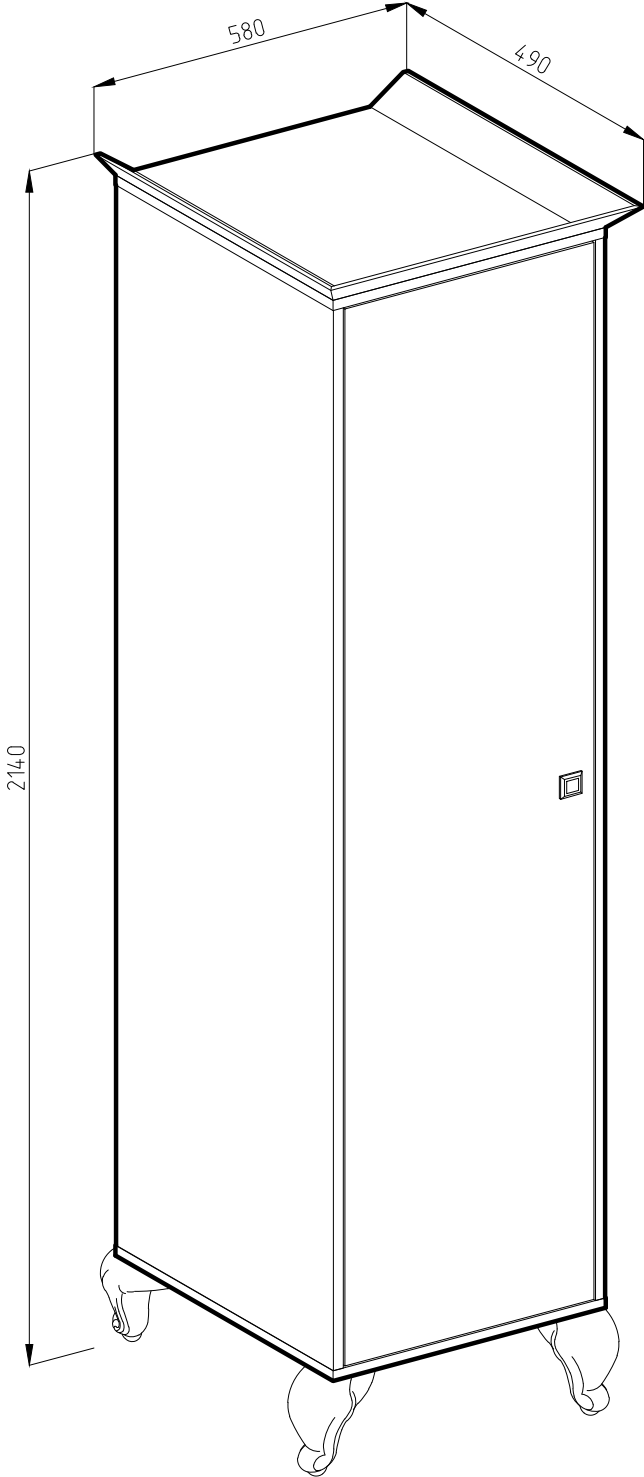

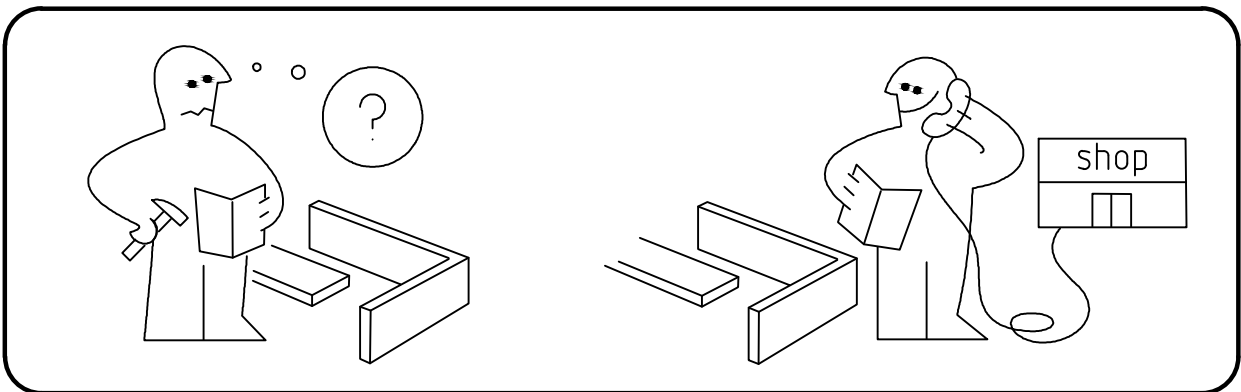

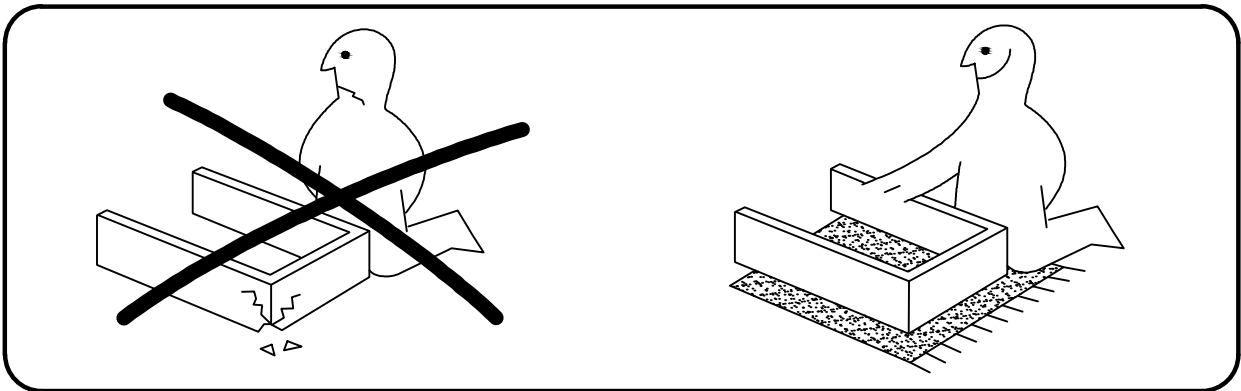

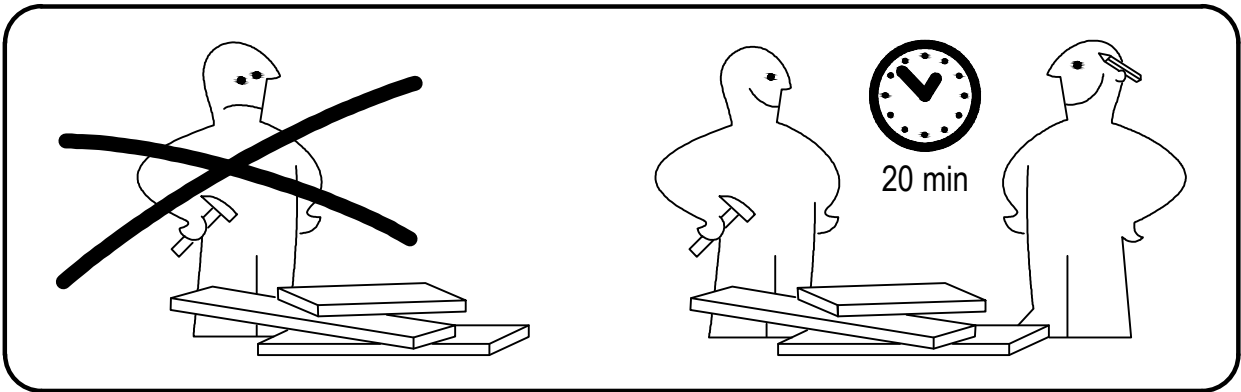

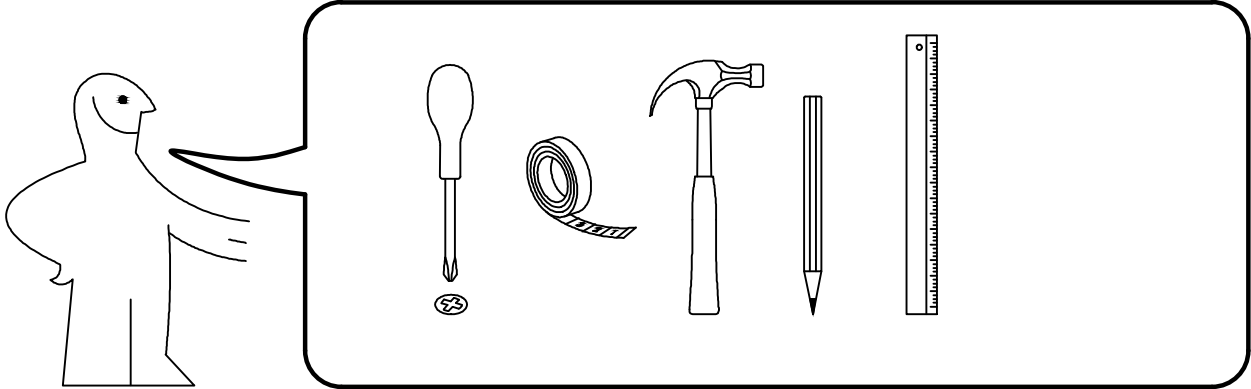



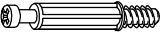



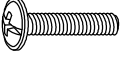

# VERONICA CABINET

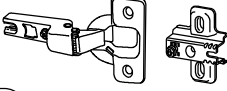

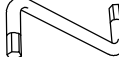

 <b>(A1)</b> 8*30mm x12	 <b>(B)</b> x4	 <b>(B1)</b> 6,3*50mm x4
 <b>(C1)</b> 5*30mm x8	 <b>(D)</b> x8	 <b>(D1)</b> 15*13mm x8
 <b>(E4)</b> 3*20mm x6	 <b>(E8)</b> 4*16mm x8	 <b>(F1)</b> 6,3*13mm x8
 <b>(G5)</b> M 4*20mm x1	 <b>(G12)</b> M6*25mm x8	 <b>(I12)</b> x1
 <b>(J1)</b> x12	 <b>(L2)</b> x4	 <b>(K7)</b> x4
 <b>(R2)</b> x1	 <b>(R3)</b> 1.4*25mm 0.02kg	 <b>(R4)</b> x1
 <b>(U2)</b> x4	 <b>(U3)</b> x2	

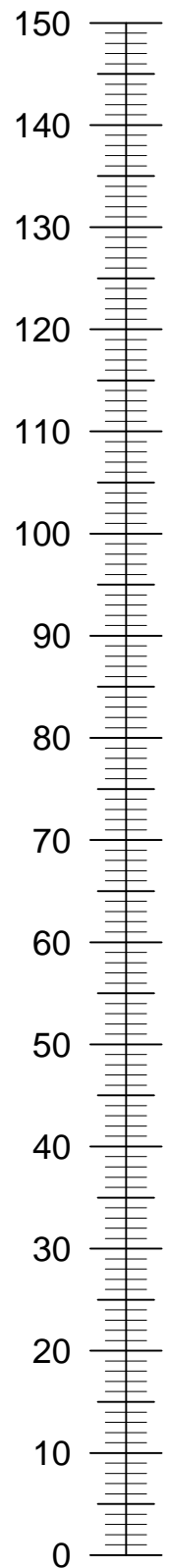

	a*b		pkg.
1L	1900x450	1	1
1R	1900x450	1	1
2	506x450	1	1
3	506x450	1	1
4	467x432	1	1
5	467x422	3	1
6	1894x462	1	2
7	1932x500	1	2
8	L=580	1	3
9L	L=487	1	3
9R	L=487	1	3

